

Product **M12-A cable connector, Contacts: 4, 6.0 - 8.0 mm, not shielded, screw clamp, IP67**

Area **M12-A series 713**
Article number **99 0429 12 04**

Illustration	Ritning	Polbild															
		<table border="1" style="margin-left: 20px;"> <thead> <tr> <th></th> <th>X</th> <th>Y</th> </tr> </thead> <tbody> <tr> <td>1</td> <td>2,50</td> <td>0,00</td> </tr> <tr> <td>2</td> <td>0,00</td> <td>2,50</td> </tr> <tr> <td>3</td> <td>-2,50</td> <td>0,00</td> </tr> <tr> <td>4</td> <td>0,00</td> <td>-2,50</td> </tr> </tbody> </table>		X	Y	1	2,50	0,00	2	0,00	2,50	3	-2,50	0,00	4	0,00	-2,50
	X	Y															
1	2,50	0,00															
2	0,00	2,50															
3	-2,50	0,00															
4	0,00	-2,50															

You can find the item description and assembly instruction on the next page.

Technical data

General features

Kontaktdesign	cable connector
Kontaktionslåsning	screw
Anslutning	screw clamp
Tvärsnitt (mm)	0.75 mm ²
Tvärsnitt (AWG)	18
Kabeluttag	6.0 - 8.0 mm
Övre gränstemperatur	85 °C
Lägre gränstemperatur	-40 °C
Customs tariff number	85369010

Electrical parameters

Märkström (40°C)	4 A (3 A UL)
Märkspänning	250 V
Märkstötspänning	2500 V
Föreoreningsgrad	3
Överspänningskategori	II
Isoleringsmaterialgrupp	III
Resistans	≤ 8 mΩ
Insulation resistance	> 10 ⁸ Ω
EMV-behörighet	not shielded
Kapslingsklass	IP67
Mekanisk livslängd	> 50 Mating cycles

Material

Kontaktmaterial	CuZn (brass)
Kontaktplätering	CuSnZn (Optalloy)
Kontaktroppsmaterial	PA
Kontaktthusmaterial	PA

Product **M12-A cable connector, Contacts: 4, 6.0 - 8.0 mm, not shielded, screw clamp, IP67**

Area **M12-A series 713**
 Article number **99 0429 12 04**

Sprängskiss

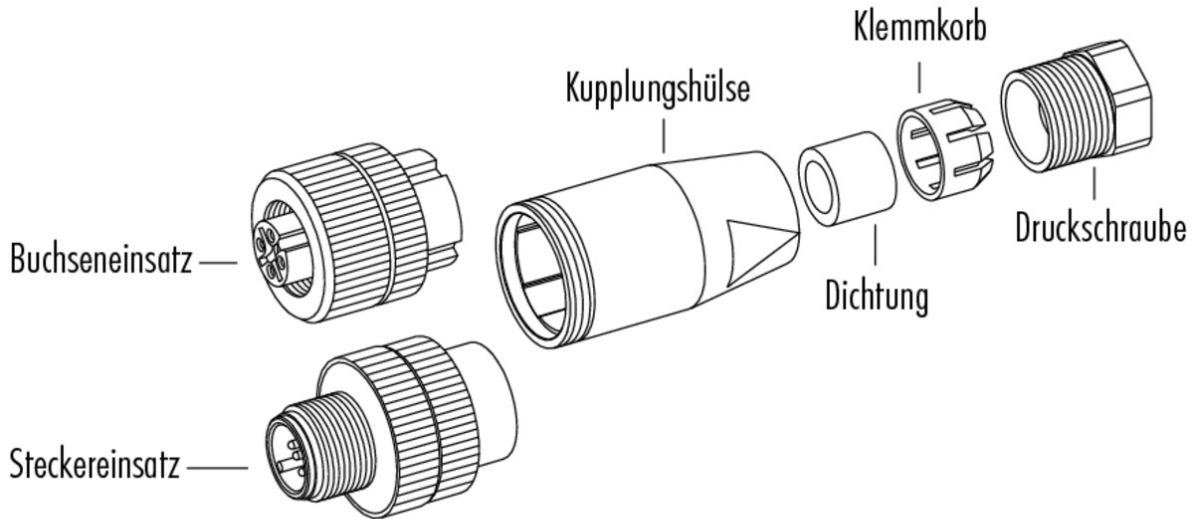

Material der Gewinderinge: Kunststoff, Zink Druckguss, Edelstahl

Installationsinstruktioner / Monteringsutdrag

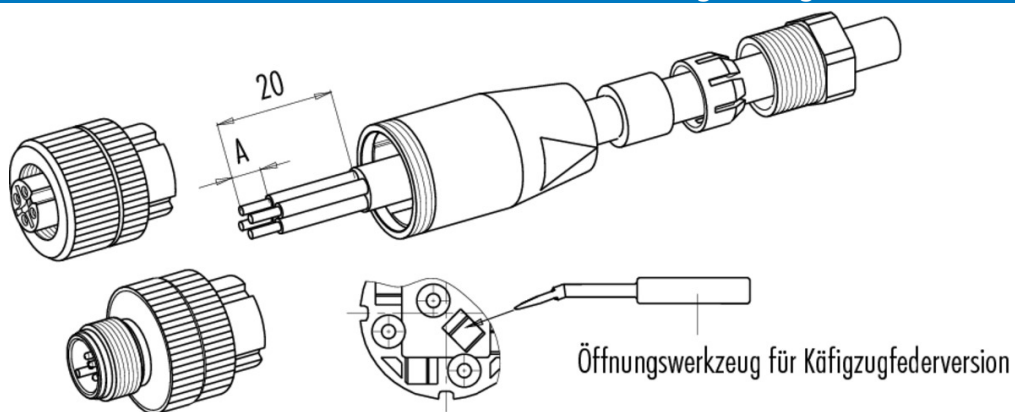

	Schraubklemmversion	Lötversion	Käfigzugfederversion
Maß A/mm	5	3,5	7

Material der Gewinderinge: Kunststoff, Zink Druckguss, Edelstahl

Product	M12-A cable connector, Contacts: 4, 6.0 - 8.0 mm, not shielded, screw clamp, IP67
Area	M12-A series 713
Article number	99 0429 12 04

Security notices

The connector must not be connected or separated under load. Non-observance and incorrect use can result in personal injury.

The connectors are designed for use in plant, control system and electrical equipment. The end user is responsible for checking whether the connectors are suitable for use in other applications.

To prevent the connector being opened unintentionally when used in electrical circuits containing hazardous life parts, the thread between the housing and the connector head must be secured using a suitable cyanoacrylate adhesive. This does not apply to connectors used in SELV and PELV circuits according to IEC 61140 (EN 61140, VDE 0140-1).

Connectors used in electrical circuits containing hazardous life parts must only be assembled and used by or under the supervision of persons with the requisite electrotechnical training, taking the applicable regulations and standards into account.

Connectors with degree of protection IP 67 and IP 68 are not suitable for use under water. When used outdoors, the connectors must be separately protected against corrosion. For further information about IP degrees of protection refer to 'Technical support' in the Download Centre.

To lock the cable connector to the equipment connector, the threaded ring is tightened until it is 'finger-tight' (approx. 50 cNm).