

Product **M5 female angled connector, Contacts: 3, not shielded, moulded on cable, IP67, M5x0.5, PUR black, 3 x 0.25 mm²**
 Area **M5 series 707**
 Article number **79 3104 35 03**

Illustration

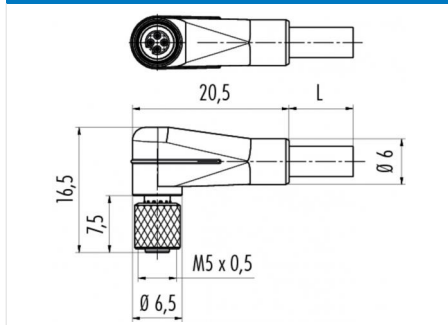

Ritning



Polbild

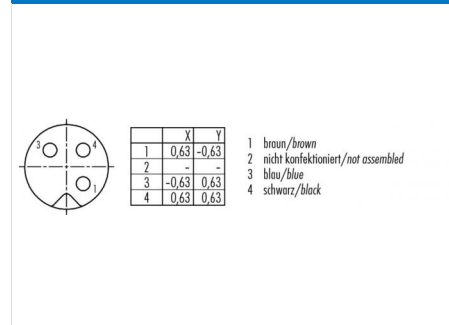

Technical data

General features

Kontaktdesign female angled connector
 Kontaktdonslåsning screw
 Anslutning moulded on cable
 Tvärsnitt (mm) 0.25 mm²
 Tvärsnitt (AWG) 24
 Övre gränstemperatur 80 °C
 Lägre gränstemperatur - 25 °C
 Customs tariff number 85444290

Electrical parameters

Märkström (40°C) 1 A
 Märkspänning 60 V
 Märkstötspänning 800 V
 Föroreningsgrad 3
 Överspänningskategori II
 Isolermaterialgrupp I
 Resistans ≤ 3 mΩ
 Insulation resistance > 10⁸ Ω
 EMV-behörighet not shielded
 Kapslingsklass IP67
 Mekanisk livslängd > 100 Mating cycles

Cable data

Kabellängd 5 m
 Mantelmaterial PUR
 Isoleringsfläta PVC
 Trådkonstruktion 32 x 0,1
 Ledarmotstånd 148Ω/Km
 Temperaturintervall kabel rör sig från C - 5 °C
 Temperaturintervall kabel rör sig till C 80 °C
 Temperaturintervall kabel fast från C -25 °C
 Temperaturintervall kabel fast till C 80 °C

Material

Kontaktmaterial CuSn (bronze)
 Kontaktplätering Au (gold)
 Kontaktkroppsmaterial PUR
 Kontakthusmaterial PUR

Product	M5 female angled connector, Contacts: 3, not shielded, moulded on cable, IP67, M5x0.5, PUR black, 3 x 0.25 mm²
Area	M5 series 707
Article number	79 3104 35 03

Security notices

The connectors are designed for use in plant, control system and electrical equipment. The end user is responsible for checking whether the connectors are suitable for use in other applications.

Connectors with degree of protection IP 67 and IP 68 are not suitable for use under water. When used outdoors, the connectors must be separately protected against corrosion. For further information about IP degrees of protection refer to 'Technical support' in the Download Centre.

To lock the cable connector to the equipment connector, the threaded ring is tightened until it is 'finger-tight' (approx. 50 cNm).