

Product **RD30 male angled connector, Contacts: 12+PE, 10.0 - 12.0 mm, Shielding is not possible, solder, IP65**
 Area **RD30 series 694**
 Article number **99 0717 70 13**

Illustration

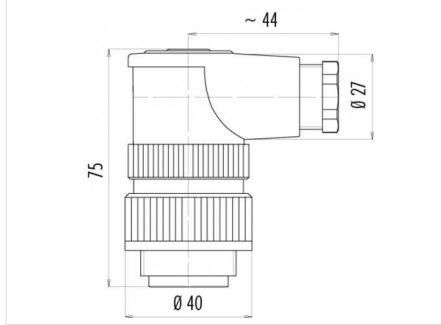

Ritning



Polbild

	X	Y
1	-2,38	-7,33
2	-6,23	-4,53
3	-7,70	0,00
4	-6,23	4,53
5	-2,38	7,33
6	2,38	7,33
7	6,23	4,53
8	7,70	0,00
9	6,23	-4,53
10	2,38	-7,33
11	2,38	-1,37
12	-2,38	-1,37
⊕	0,00	2,74

Derating curve

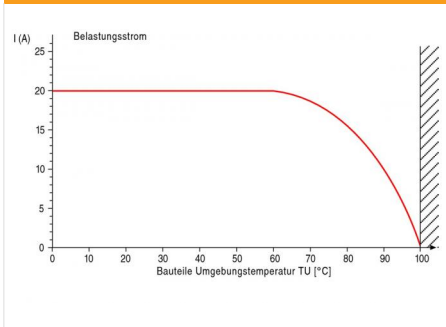

You can find the assembly instruction on the next page.

Technical data

General features

Kontaktdesign	male angled connector
Kontaktionslösning	screw
Anslutning	solder
Tvärsnitt (mm)	1.00 mm ²
Tvärsnitt (AWG)	17
Kabeluttag	10.0 - 12.0 mm
Övre gränstemperatur	100 °C
Lägre gränstemperatur	- 40 °C
Customs tariff number	85369010

Electrical parameters

Märkström (40°C)	6 A
Märkspänning	250 V
Märksstötspänning	4000 V
Föroreningsgrad	3
Överspanningskategori	III
Isoleringsmaterialgrupp	III
Resistans	≤ 5 mΩ
Insulation resistance	≥ 10 ¹⁰ Ω
EMV-behörighet	Shielding is not possible
Kapslingsklass	IP65
Mekanisk livslängd	> 500 Mating cycles

Material

Kontaktmaterial	CuZn (brass)
Kontaktplätning	Ag (silver)
Kontaktkroppsmaterial	PA (UL 94 HB)
Kontakthusmaterial	PA

Product **RD30 male angled connector, Contacts: 12+PE, 10.0 - 12.0 mm, Shielding is not possible, solder, IP65**

Area **RD30 series 694**
Article number **99 0717 70 13**

Installationsinstruktioner / Monteringsutdrag

1. Winkelkoppe, Winkelhülse, Dichtung, Klemmkorb und Druckschraube auffädeln.
2. Kontakteinsatz in Gehäuse einclippen.
3. Leiter abmontieren, abisolieren und anschließen.
4. Winkelhülse mit vormontiertem Gehäuse bis zum mechanischen Anschlag fest verschrauben.
5. Teile gemäß Darstellung montieren.

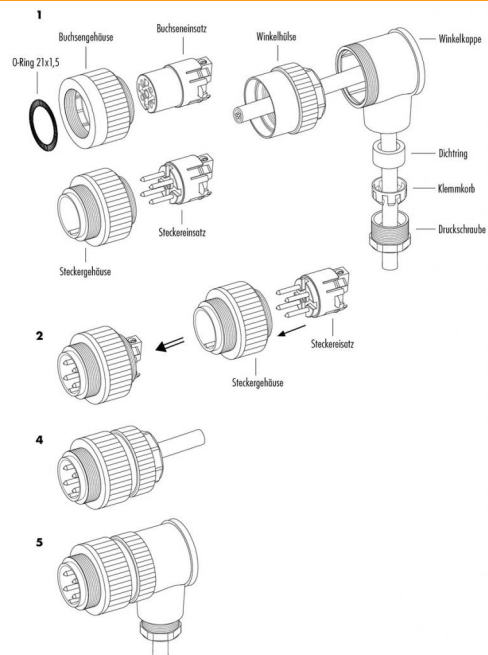

Product	RD30 male angled connector, Contacts: 12+PE, 10.0 - 12.0 mm, Shielding is not possible, solder, IP65
Area	RD30 series 694
Article number	99 0717 70 13

Security notices

The connector must not be connected or separated under load. Non-observance and incorrect use can result in personal injury.

The connectors are designed for use in plant, control system and electrical equipment. The end user is responsible for checking whether the connectors are suitable for use in other applications.

To prevent the connector being opened unintentionally when used in electrical circuits containing hazardous life parts, the thread between the housing and the connector head must be secured using a suitable cyanoacrylate adhesive. This does not apply to connectors used in SELV and PELV circuits according to IEC 61140 (EN 61140, VDE 0140-1).

Connectors used in electrical circuits containing hazardous life parts must only be assembled and used by or under the supervision of persons with the requisite electrotechnical training, taking the applicable regulations and standards into account.

Connectors with degree of protection IP 67 and IP 68 are not suitable for use under water. When used outdoors, the connectors must be separately protected against corrosion. For further information about IP degrees of protection refer to 'Technical support' in the Download Centre.

To lock the cable connector to the equipment connector, the threaded ring is tightened until it is 'finger-tight' (approx. 50 cNm).