

Product **Snap-In IP67 (miniature) female cable connector, Contacts: 5, 4.0 - 6.0 mm, not shielded, solder, IP67**  
Area **Snap-In IP67 (miniature) series 720**  
Article number **99 9114 400 05**

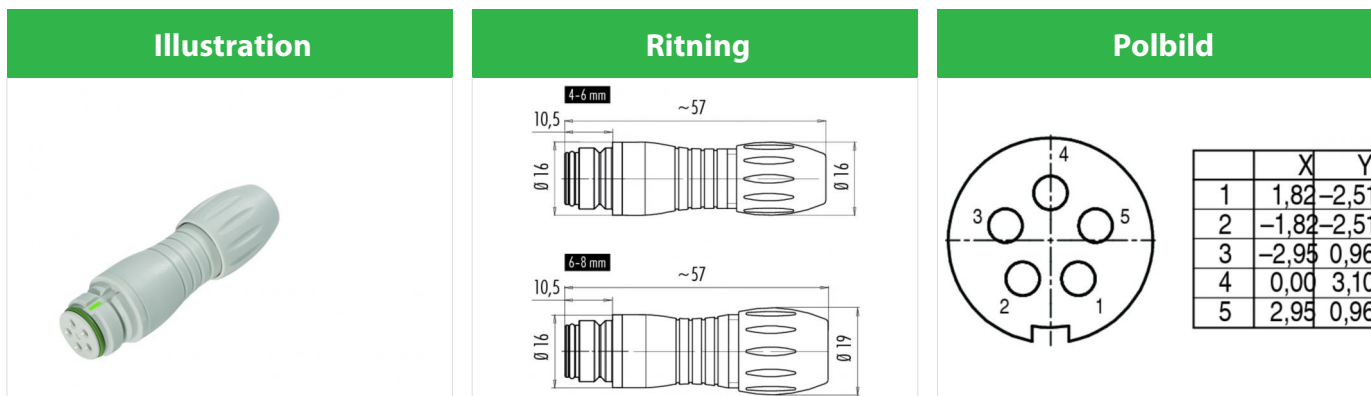

You can find the item description and assembly instruction on the next page.

## Technical data

### General features

Kontaktdesign	female cable connector
Kontaktionslåsning	snap
Anslutning	solder
Tvärsnitt (mm)	0.75 mm <sup>2</sup>
Tvärsnitt (AWG)	18
Kabeluttag	4.0 - 6.0 mm
Övre gränstemperatur	85 °C
Lägre gränstemperatur	-40 °C
Customs tariff number	85369010

### Electrical parameters

Märkström (40°C)	5 A
Märkspänning	125 V
Märkstötspänning	1500 V
Föroreningsgrad	2
Överspänningskategori	II
Isoleringsmaterialgrupp	II
Resistans	≤ 3 mΩ
Insulation resistance	≥ 10 <sup>10</sup> Ω
EMV-behörighet	not shielded
Kapslingsklass	IP67
Mekanisk livslängd	> 500 Mating cycles

### Material

Kontaktmaterial	CuZn (brass)
Kontaktplätering	Au (gold)
Kontaktkroppsmaterial	PA (UL 94 V-0)
Kontaktthusmaterial	PA

Product **Snap-In IP67 (miniature) female cable connector, Contacts: 5, 4.0 - 6.0 mm, not shielded, solder, IP67**

Area **Snap-In IP67 (miniature) series 720**  
Article number **99 9114 400 05**

### Sprängskiss



### Installationsinstruktioner / Monteringsutdrag

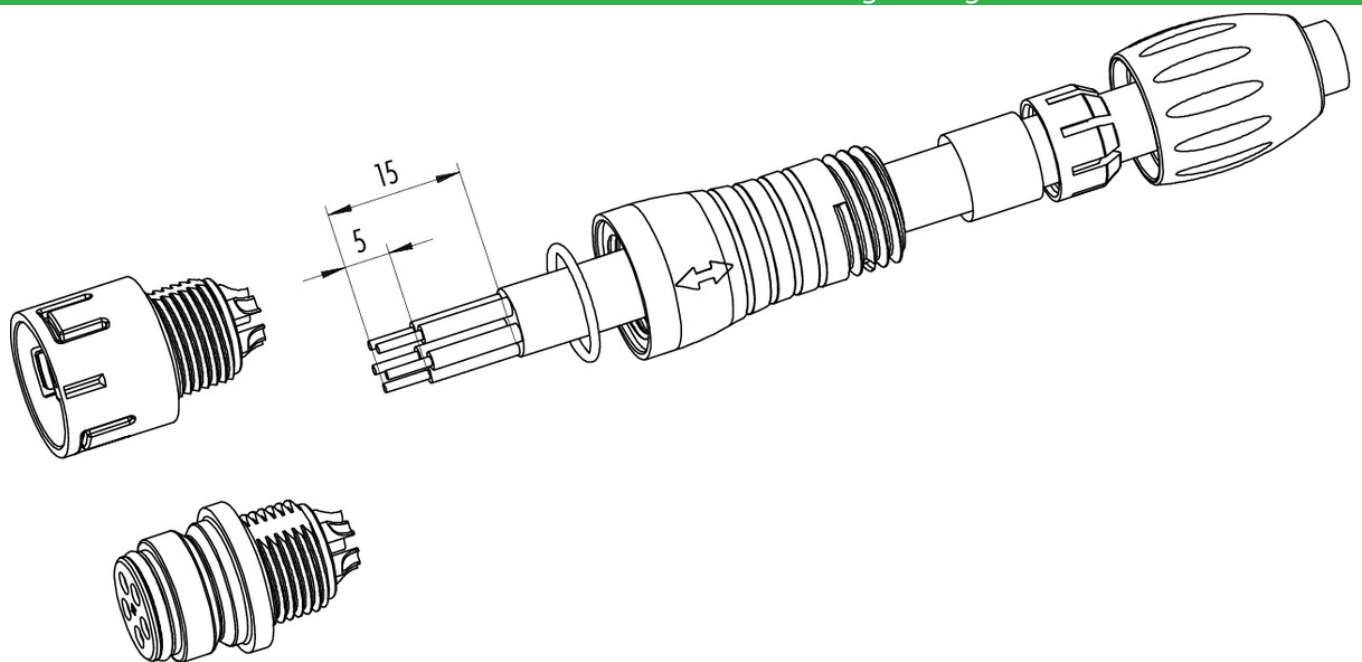

Product	<b>Snap-In IP67 (miniature) female cable connector, Contacts: 5, 4.0 - 6.0 mm, not shielded, solder, IP67</b>
Area	<b>Snap-In IP67 (miniature) series 720</b>
Article number	<b>99 9114 400 05</b>

## Security notices

The connector must not be connected or separated under load. Non-observance and incorrect use can result in personal injury.

The connectors are designed for use in plant, control system and electrical equipment. The end user is responsible for checking whether the connectors are suitable for use in other applications.

To prevent the connector being opened unintentionally when used in electrical circuits containing hazardous life parts, the thread between the housing and the connector head must be secured using a suitable cyanoacrylate adhesive. This does not apply to connectors used in SELV and PELV circuits according to IEC 61140 (EN 61140, VDE 0140-1).

Connectors used in electrical circuits containing hazardous life parts must only be assembled and used by or under the supervision of persons with the requisite electrotechnical training, taking the applicable regulations and standards into account.

Connectors with degree of protection IP 67 and IP 68 are not suitable for use under water. When used outdoors, the connectors must be separately protected against corrosion. For further information about IP degrees of protection refer to 'Technical support' in the Download Centre.