

# LED Leuchten

LED Lights



## LED Leuchten

### LED Lights

#### LED-Leuchte

- Drei verschiedene Leuchtenlängen
- Schutzart IP69K<sup>1)</sup>
- Schneller Einbau
- Montagefreundliches Befestigungskit
- Weiteres Zubehör auf Anfrage

#### Anschluss-System

- M12 A-kodiert
- Konfektionierbare Kabeldose
- Schraubklemmanschluss
- Umspritzte Kabeldose
- 4-polig

#### LED Light

- Three different light lengths
- Degree of protection IP69K<sup>1)</sup>
- Quick fitting
- Easy installation kit
- More accessories upon request

#### Termination System

- M12 A-coded
- Field-wireable female cable connector
- Screw clamp termination
- Moulded female cable connector
- 4 contacts

<sup>1)</sup>Erläuterung der Schutzarten siehe technische Informationen./ <sup>1)</sup>Explanation of protection standards see technical information.

LED-Leuchte  
LED light

Abbildung / Figure



Maßzeichnung / Drawing

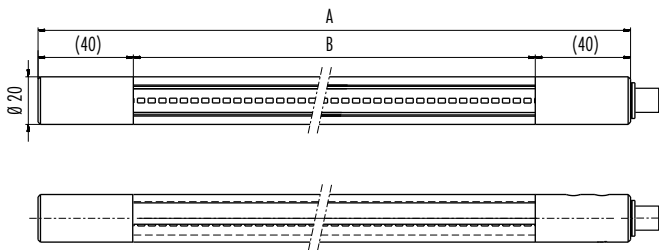

Version	Länge (A) Length (A)	Ausleuchtbereich (B) Length of lightening (B)
00	250 mm	170 mm
01	358 mm	278 mm
02	412 mm	332 mm



Bestell-Daten / Order Data

Polzahl Contacts	Länge Length	Beleuchtungsstärke Illumination	Alu Alu	VA Stainless steel	
4	250 mm	108 Lux	28 1200 000 04	28 1300 000 04	<b>ECOLAB</b>
4	358 mm	173 Lux	28 1201 000 04	28 1301 000 04	<b>ECOLAB</b>
4	412 mm	198 Lux	28 1202 000 04	28 1302 000 04	<b>ECOLAB</b>

Technische Daten / Specifications

Länge	250 mm	358 mm	412 mm	Length
Leuchtenlänge	250 mm	358 mm	432 mm	Light length
Durchmesser		20 mm		Diameter
Ausleuchtebereich	170 mm	278 mm	332 mm	Length of lightening
Gehäusmaterial	Alu/VA/Alu/stainless steel			Material of body
Leistung	5,7 W	9,35 W	11,04 W	Rated Power
Lichtstrom	410 lm	654 lm	746 lm	Luminosity
Anzahl LEDs pro Leuchte	60	96	114	No. of LEDs per lamp
Lichtabstrahlwinkel	120°			Angle of light radiation
Leuchten-Lichtausbeute	72 lm/W	70 lm/W	68 lm/W	Light yield
Beleuchtungsstärke (1m)	108 Lux	173 Lux	198 Lux	Illumination (1m)
Lichtfarbe	4.000 K (nw)			Lightcolour (3Step MacAdam)
Farbwiedergabe (RA/CRI)	> 90			Colour rendering (RA/CRI)
Spannung	24 V DC			Voltage
Betriebstemperatur	- 25 °C /+ 60 °C			Temperature in use
Lagertemperatur	- 40 °C /+ 85 °C			Storage temperature
Schutzart <sup>1)</sup>	IP67, IP68 <sup>2)</sup> , IP69K			Degree of protection <sup>1)</sup>
Lebensdauer <sup>2)</sup>	50.000 h			Durability <sup>2)</sup>
Stromaufnahme	238 mA	390 mA	460 mA	Power input
M12 Anschluss	4 pol/pin			M12 connection
Profibus	über Interface/per interface			Profinet

<sup>1)</sup> In montiertem Zustand mit umspritzter Binder M12 Buchsenleitung./Fully assembled with moulded Binder M12 female connector.

<sup>2)</sup> Lebensdauer L70 bei 25 °C./Lifetime L70 life expectancy at 25 °C.

<sup>3)</sup> 2m.

Polbild  
Contact arrangement

Stifteinsatz (Steckseite)  
Male insert (mating side)

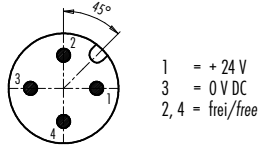

Lichtverteilungskurve  
Light distribution curve

IF = 80 mA TS = 25 °C

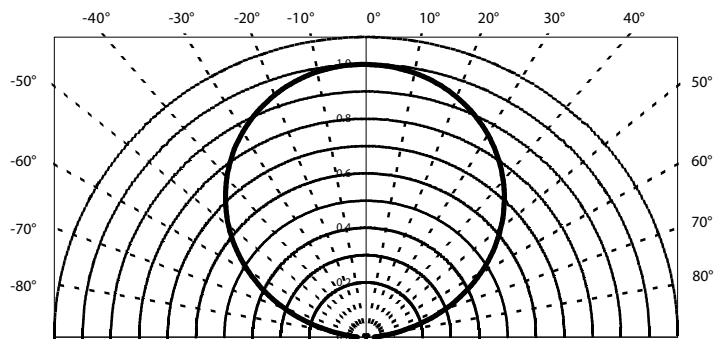

**M12 Anschluss Kabeldose, Schraubklemmanschluss**  
M12 female cable connector, screw clamp connection

Abbildung / Figure



Maßzeichnung / Drawing

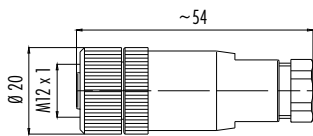

**M12 Anschluss Kabeldose, umspritzt**  
M12 female cable connector, moulded

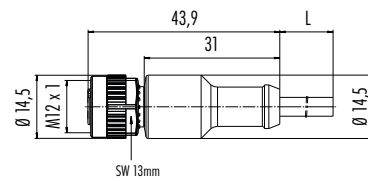

Bestell-Daten / Order Data

Polzahl Contacts	Kabeldurchlass Cable outlet	Bestell-Nr. Ordering-No.
4	4–6 mm	28 1260 000 04

Polzahl Contacts	Kabelmantel Cable jacket	Kabel-Länge Cable length	Bestell-Nr. Ordering-No.
4	PUR	2 m	28 1270 020 04
		5 m	28 1270 050 04

Technische Daten / Specifications

Polzahl	4 (konfektionierbar/for assembly)	4 (umspritzt/moulded)	Number of contacts
Umspritzt	—	ja/yes	Overmolded
Abmessungen Stecker	20 x 54 mm	14,5 x 43,9 mm	Dimensions connector
Material Gehäuse/Kabel	PA	PUR	Material of housing/cable
Anschlussquerschnitt	max. 0,75 mm <sup>2</sup> (max. AWG 20)	4 x 0,34 mm <sup>2</sup>	Wire gauge
Länge (andere Längen auf Anfrage)	—	2 m, 5 m	Length (other lengths on request)
Schutzart <sup>1)</sup>	IP67	IP67, IP68 <sup>2)</sup> , IP69K	Degree of protection <sup>1)</sup>

**Polbild**  
Contact arrangement

**Buchseinsatz (Steckseite)**  
Female insert (mating side)

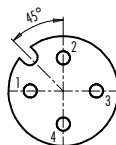

- 1 braun/brown = + 24 V
- 2 weiß/white = frei/free
- 3 blau/blue = 0 V DC
- 4 schwarz/black = frei/free

**Netzteil, konfektionierbar**  
Power supply, assembly possible

Abbildung / Figure



**Netzteil mit Eurostecker**  
Power supply with euro plug



Maßzeichnung / Drawing

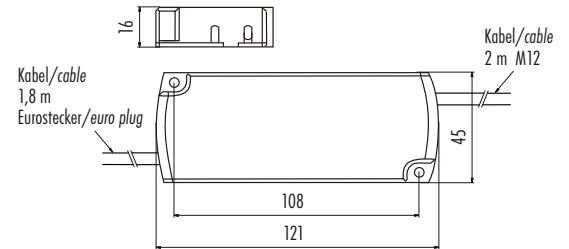
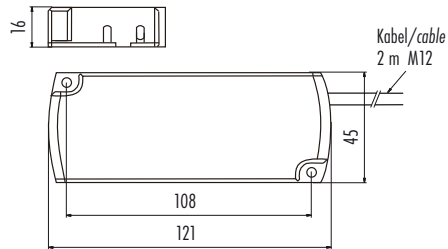

Bestell-Daten / Order Data

Bestell-Nr. Ordering-No.
28 1241 020 04

Bestell-Nr. Ordering-No.
28 1240 020 04

Technische Daten / Specifications

Abmessungen	77 mm x 49 mm x 24 mm (L x B x H/ L x W x H)	Dimensions
Spannung primär	AC 220–240 V, 50/60 Hz	Input
Spannung sekundär	24 V F-2/Class 2	Output
Strom	0 – 0,5 A	Current
Leistung	0 – 15 W	Rated Power
Ta	- 20 °C /+ 50 °C	Ta
Tc	+ 85 °C	Tc
Kurzschlussfest	ja/yes	Short-circuit proof
Effektivität	≥ 80 %	Efficiency
Ruhestrom	≤ 0,1 W	Standby current
Kennzeichen	CE, SELV	Feature

Befestigungselemente, zwei Stück  
Fixing elements, two pieces

Abbildung / Figure



Maßzeichnung / Drawing

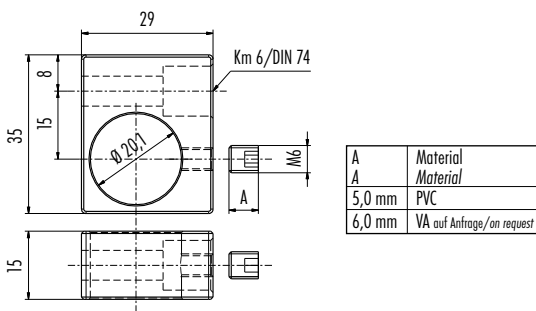

Bestell-Daten / Order Data

Material Material	Bestell-Nr. Ordering-No.
Alu	28 1230 300 00
VA	28 1330 300 00



Technische Daten / Specifications

Abmessungen	35 mm x 29 mm x 15 mm (L x B x H/ L x W x H)	Dimensions
Material	Alu (Kanten gerundet)/Alu (rounded edges), VA	Material
Fixierschraube (Material)	PVC	Fixing screw (material)

