

Product description	M12-A female cable connector, Contacts: 4, not shielded, moulded on cable, IP69K, UL listed, PUR black, 4 x 0.34 mm²
Area	M12-A series 763
Order number	77 3630 0000 50004-0500

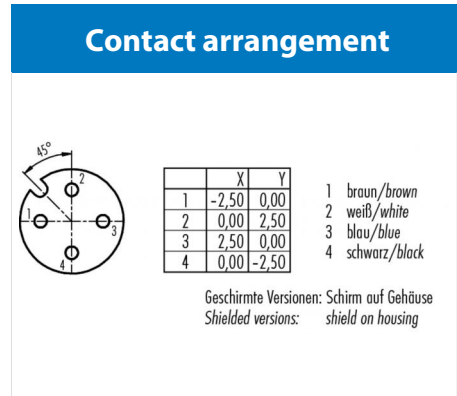
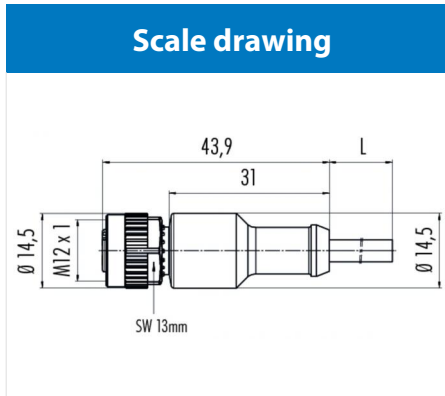

Technical data

General values

Connector design	female cable connector
Connector locking system	screw
Termination	moulded on cable
Wire gauge (mm)	0.34 mm ²
Wire gauge (AWG)	22
Upper limit temperature	90 °C
Lower limit temperature	- 25 °C
Customs tariff number	85444290

Cable data

Cable length	5 m
Sheath material	PUR
Single-lead insulation	PP
Single-lead structure	42 x 0,1
Cable diameter	4.7 mm
Conductor resistance	60 Ω/Km
Temperature range, moving cable, °C from	- 25 °C
Temperature range, moving cable, °C to	90 °C
Temperature range, fixed cable, °C from	-50 °C
Temperature range, fixed cable, °C to	90 °C
Bending radius, fixed cable	≥ 5 x Ø
Bending radius, moving cable	≥ 10 x Ø
Approval 1	UL listed
UL style 1	AWM20549

Electrical values

Rated current (40 °C)	4 A
Rated voltage	10 - 30 V
Rated impulse voltage	500 V
Pollution degree	3
Overvoltage category	II
Insulating material group	II
Volume resistivity	≤ 3 mΩ
Insulation resistance	≥ 10 ¹⁰ Ω
EMC compliance	not shielded
Degree of protection	IP69K
Mechanical operation	> 100 Mating cycles

Material

Contact material	CuSn (bronze)
Contact plating	Au (gold)
Contact body material	PUR
Housing material	PUR

Product description	M12-A female cable connector, Contacts: 4, not shielded, moulded on cable, IP69K, UL listed, PUR black, 4 x 0.34 mm²
Area	M12-A series 763
Order number	77 3630 0000 50004-0500

Security notices

The connectors are designed for use in plant, control system and electrical equipment. The end user is responsible for checking whether the connectors are suitable for use in other applications.

Connectors with degree of protection IP 67 and IP 68 are not suitable for use under water. When used outdoors, the connectors must be separately protected against corrosion. For further information about IP degrees of protection refer to 'Technical support' in the Download Centre.

To lock the cable connector to the equipment connector, the threaded ring is tightened until it is 'finger-tight' (approx. 50 cNm).